



CONTROL

with ALPHAESS



Models:
SMILE5
SMILE-G3

CATCH Power
A trademark of Project H Pty Ltd
180 Dumaresq Street
Glen Innes
NSW 2370
Australia
Ph: +64 2 5700 5717
W: www.Catchpower.com.au
E: sales@catchpower.com.au

Installation Overview

1. Install the Inverter as per the Inverter Installation Guide.

NOTE: You will need to run an ethernet connection to the inverter. CATCH Control requires modbus/TCP which is only available through the inverters LAN port.

2. Install the CATCH Control as per the CATCH Electricians Guide.
3. Adjust the CATCH CT wiring as show in this document.
4. Connect the RS485 bus between the CATCH Control and the inverter as shown in this document.
5. Run the CATCH Commissioner wizard up to Step 6.
6. Complete the inverter Commissioning as per the manufacturers install guide.
7. Setup modify the inverter setup as outlined in this document.
8. Finish the CATCH Commissioner wizard.
9. Perform a SUNSPEC Scan in the CATCH Configurator to connect the CATCH Control to the inverter over the local network.

CT Configuration

The CT Configuration for I-STORE Hybrid installation is slightly different, the diagram below outlines how the CT's need to be arranged.

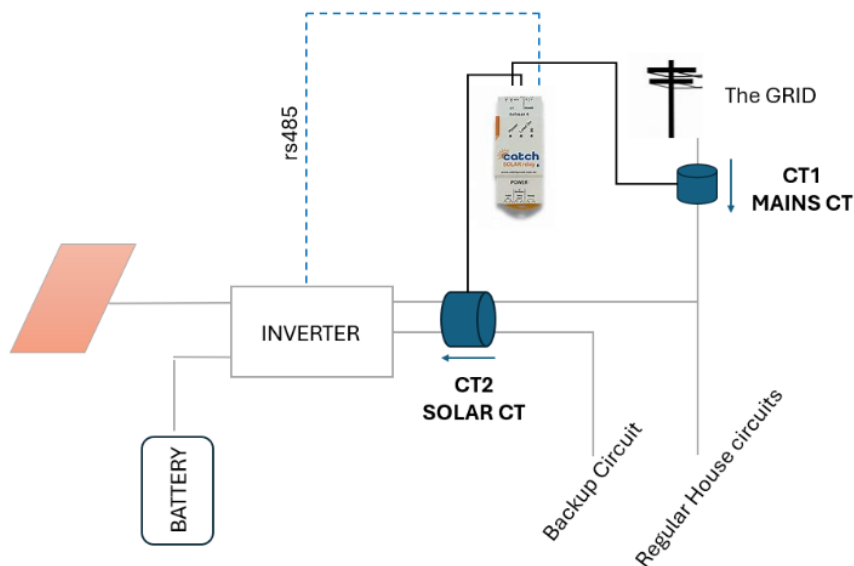

NOTE: How CT2 (W2) has the backup circuit and the AC Port of the inverter passing through it. If you cannot get both wires through one CT, you can parallel the two CT's into the W2 terminal, Just make the arrow on both CT's is pointing towards the inverter.

IMPORTANT



You will configure the inverter to use a meter instead of CT's

ALPHAESS – SMILE-G3 RS485 Connection

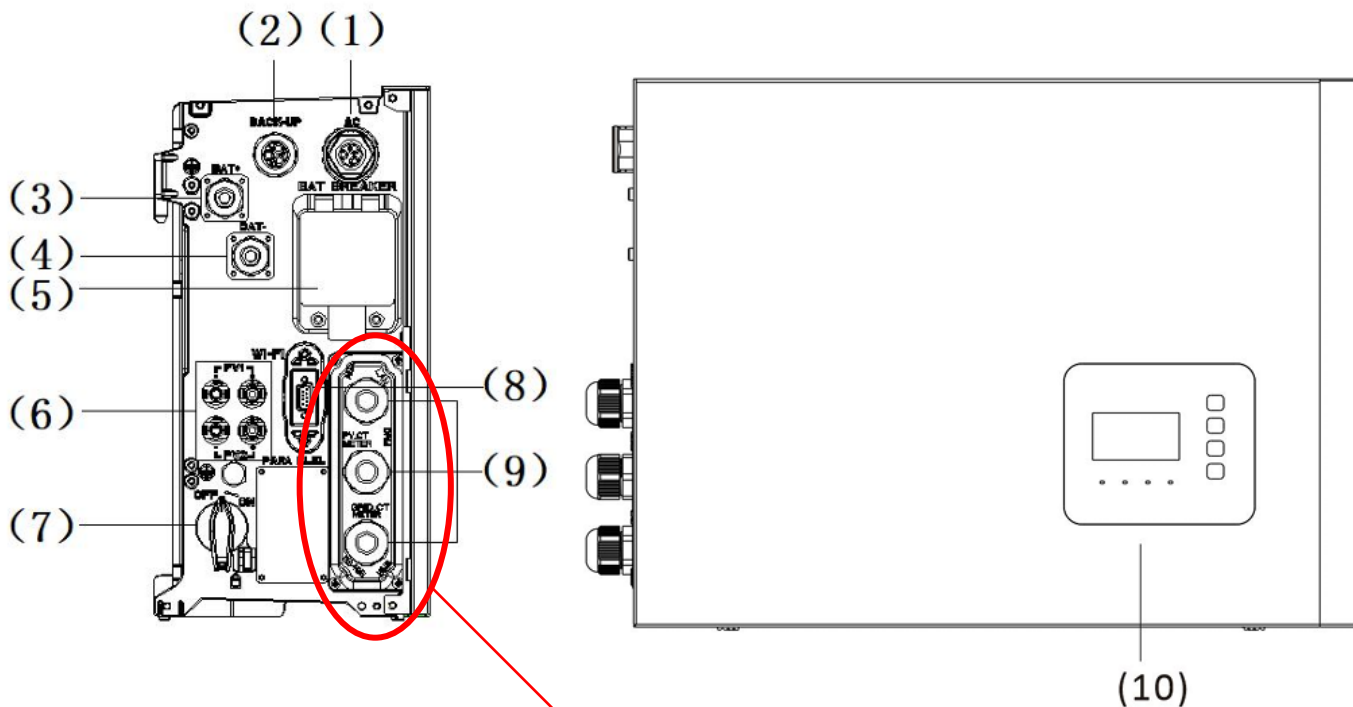

RS485 meter connection is found under this plate.

IMPORTANT



You will configure the inverter to use a meter instead of CT's

ALPHAESS – SMILE-G3 RS485 Connection

Plug into the **METER/GRID CT** port. Do not plug into the RS485 port

Ensure the data cable is rated for the voltages it will be in close proximity to. A 120 Ohm terminating resistor may be required at the CATCH CONTROL terminals as shown in the diagram below if the cable run is longer than 10m.

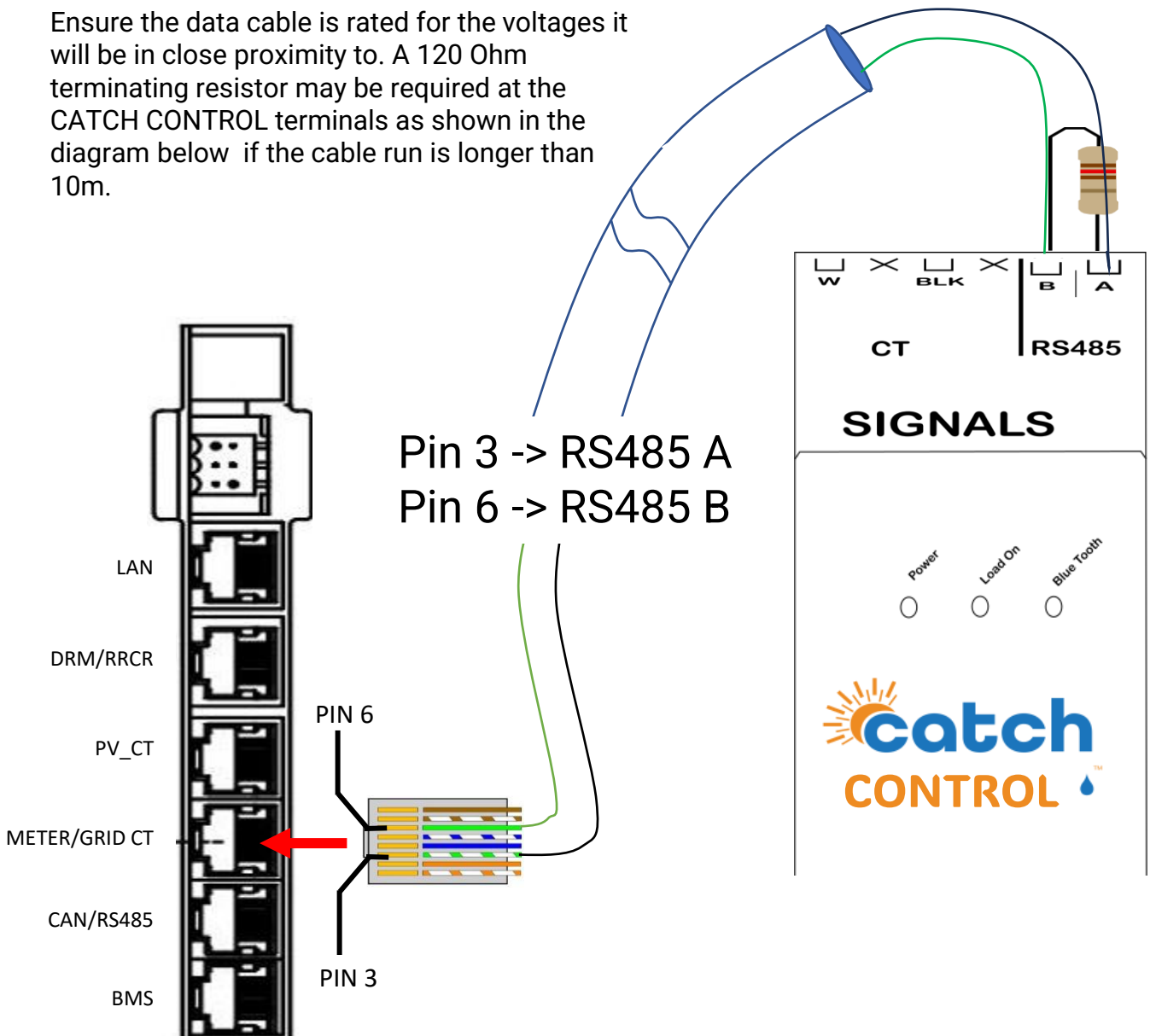

IMPORTANT



You will configure the inverter to use a meter instead of CT's

ALPHAESS – SMILE5 RS485 Connection

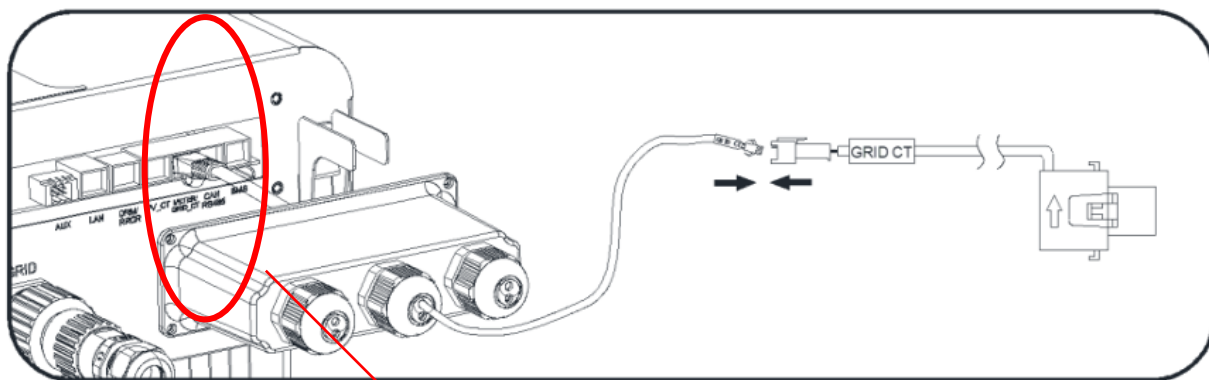

RS485 meter connection is found under this plate.

IMPORTANT



You will configure the inverter to use a meter instead of CT's

ALPHAESS – SMILE5 RS485 Connection

Plug into the **METER/GRID CT** port. Do not plug into the RS485 port

Ensure the data cable is rated for the voltages it will be in close proximity to. A 120 Ohm terminating resistor may be required at the CATCH CONTROL terminals as shown in the diagram below if the cable run is longer than 10m.

Pin 3 -> RS485 A
Pin 6 -> RS485 B

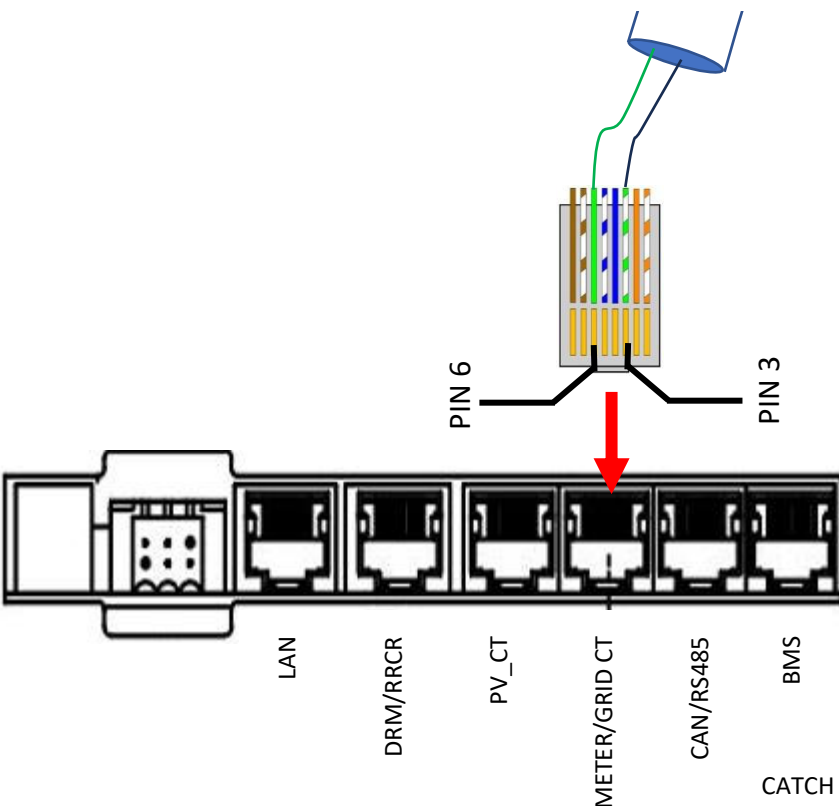
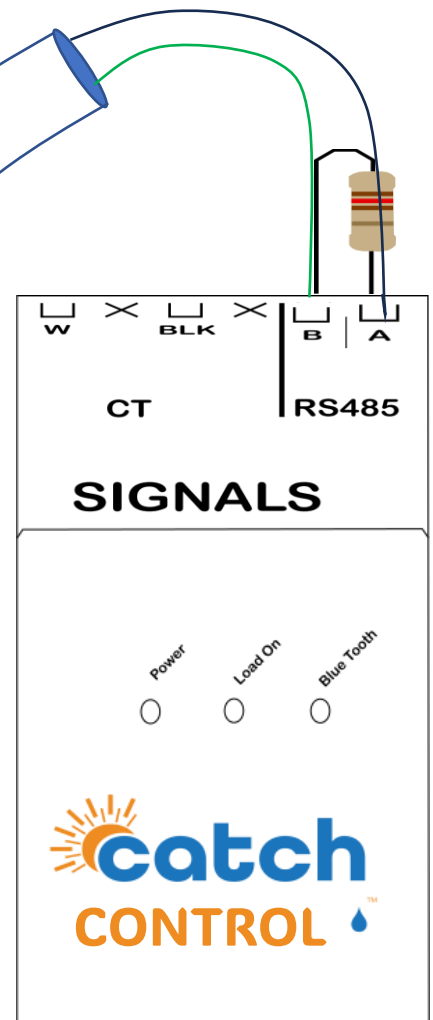

CATCH Commissioning Wizard

1. Log into the CATCH Configurator and run the Commissioner.



CATCH Power Configurator

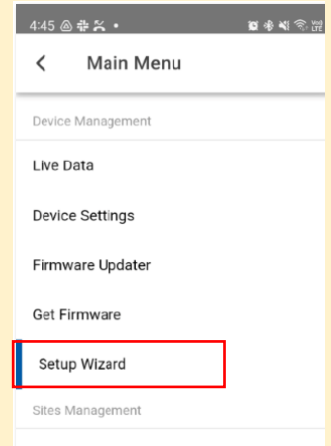

2. Follow the Commissioner step by Step.

Step 6: Inverter Control

choose **ALPHA ESS SMILE** as the meter.

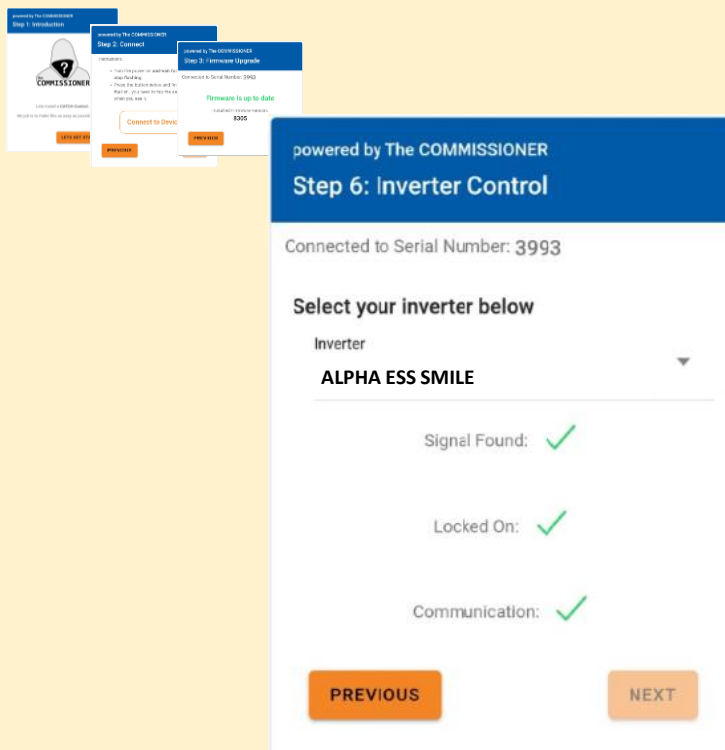

Choose: **ALPHA ESS SMILE**

You will need to get All **GREEN** ticks before you can continue, but that wont happen until you commission the ALPHA inverter, which is what we are going to do next.

Inverter Setup – Register the Meter

The configuration of the ALPHAESS inverter is done through the **AlphaESS** App

Follow the ALPHAESS commissioning process as outline in the Installation Guide.

Once the inverter is setup as per the above guide follow these steps:

Step 1: On the home screen choose **menu > Meter Information**

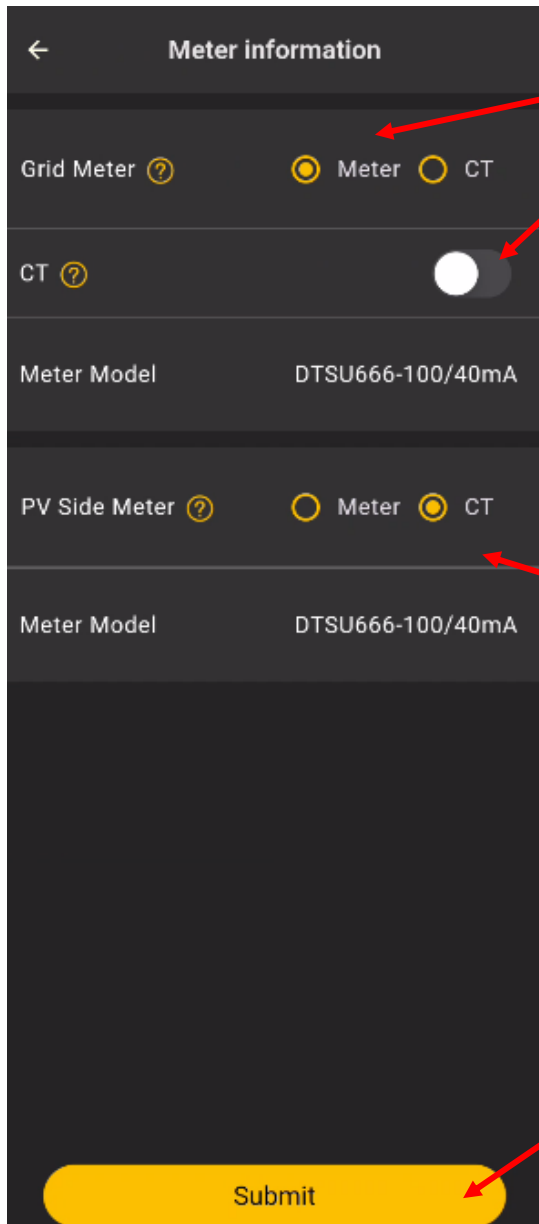

Set to **Meter**, and
CT should be turned
OFF

If you see **DTSU666-100/40mA**
here it means the meter and
inverter are talking

Leave this as **CT**

Press **SUBMIT**

Inverter Setup – Register the Meter

Step 2: On the home screen choose **menu > Other Settings**

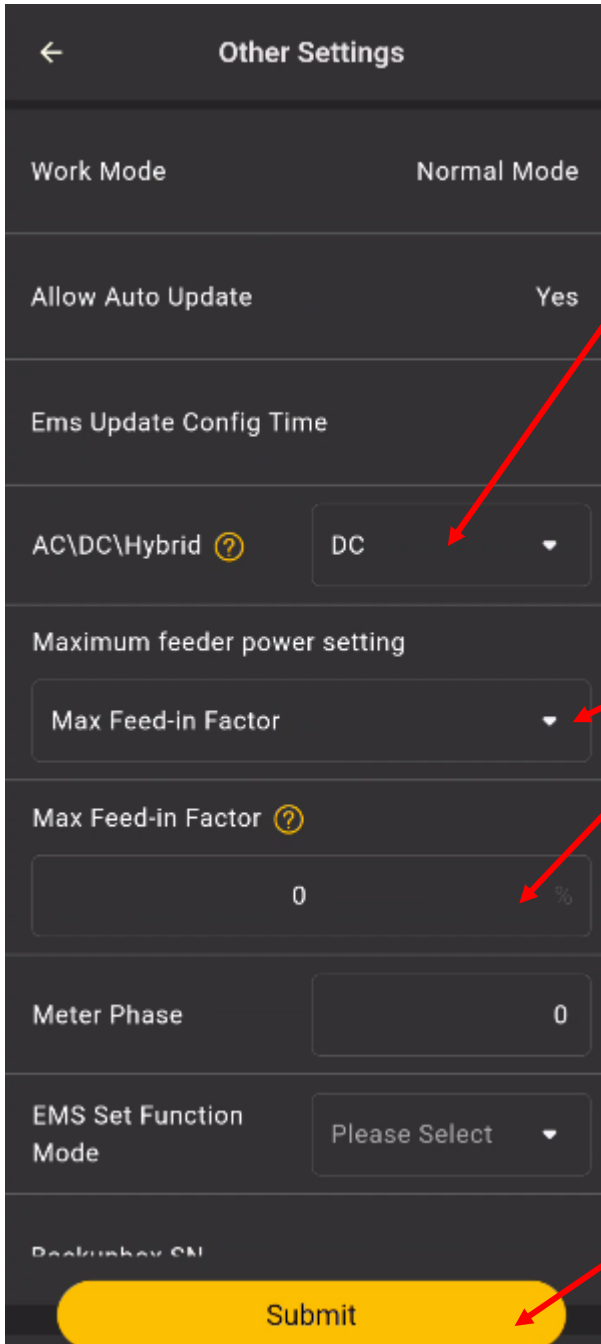

← Other Settings

Work Mode Normal Mode

Allow Auto Update Yes

Ems Update Config Time

AC\DC\Hybrid ? DC

Maximum feeder power setting

Max Feed-in Factor

Max Feed-in Factor ?

0 %

Meter Phase 0

EMS Set Function Mode Please Select

Beckhoff SM

Submit

Set the Inverter Mode. Choose either **AC** or **DC**.

If your scenario is a Hybrid scenario then you may need a second CATCH Control to pick up the extra solar, but in hybrid scenario pretend the extra solar is not there and choose the correct scenario based on that.

Set the export limit of the inverter to ZERO

Press **SUBMIT**

Inverter Setup – Turn Off Battery Settings

Step 2: On the home screen choose menu > Charge/Discharge setting

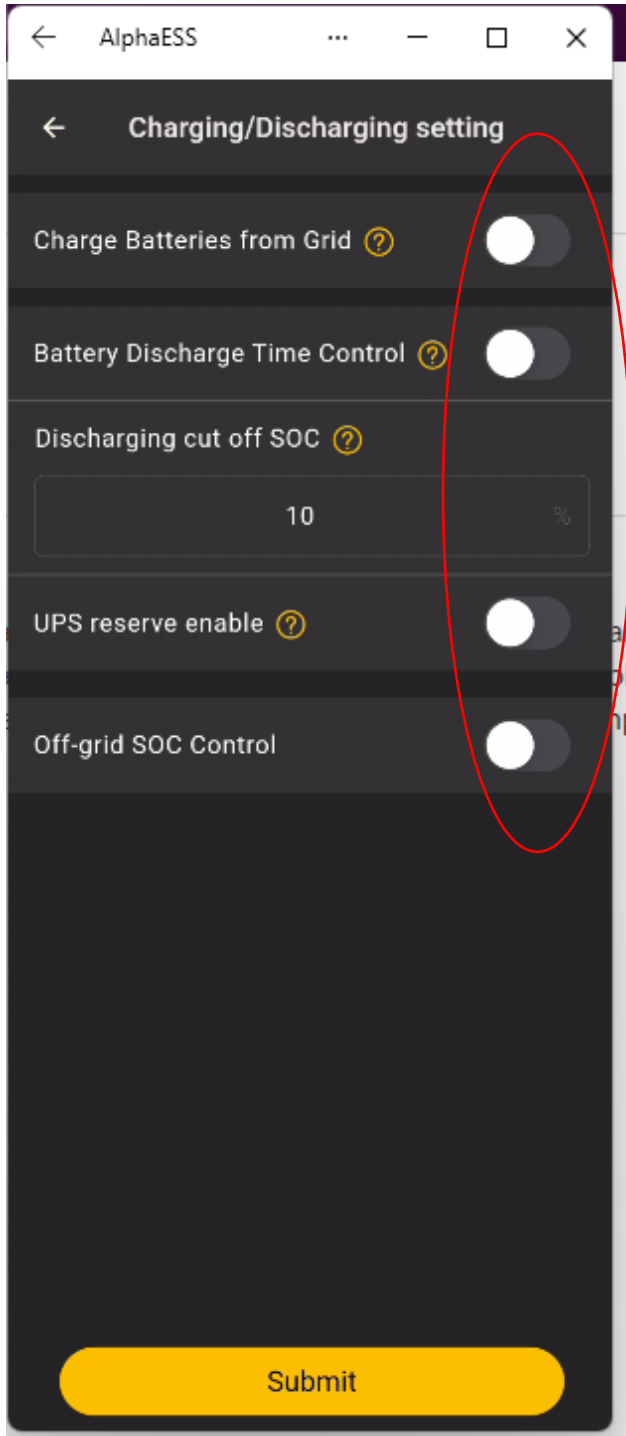

ALL OFF

Inverter Setup – Ethernet network Connection

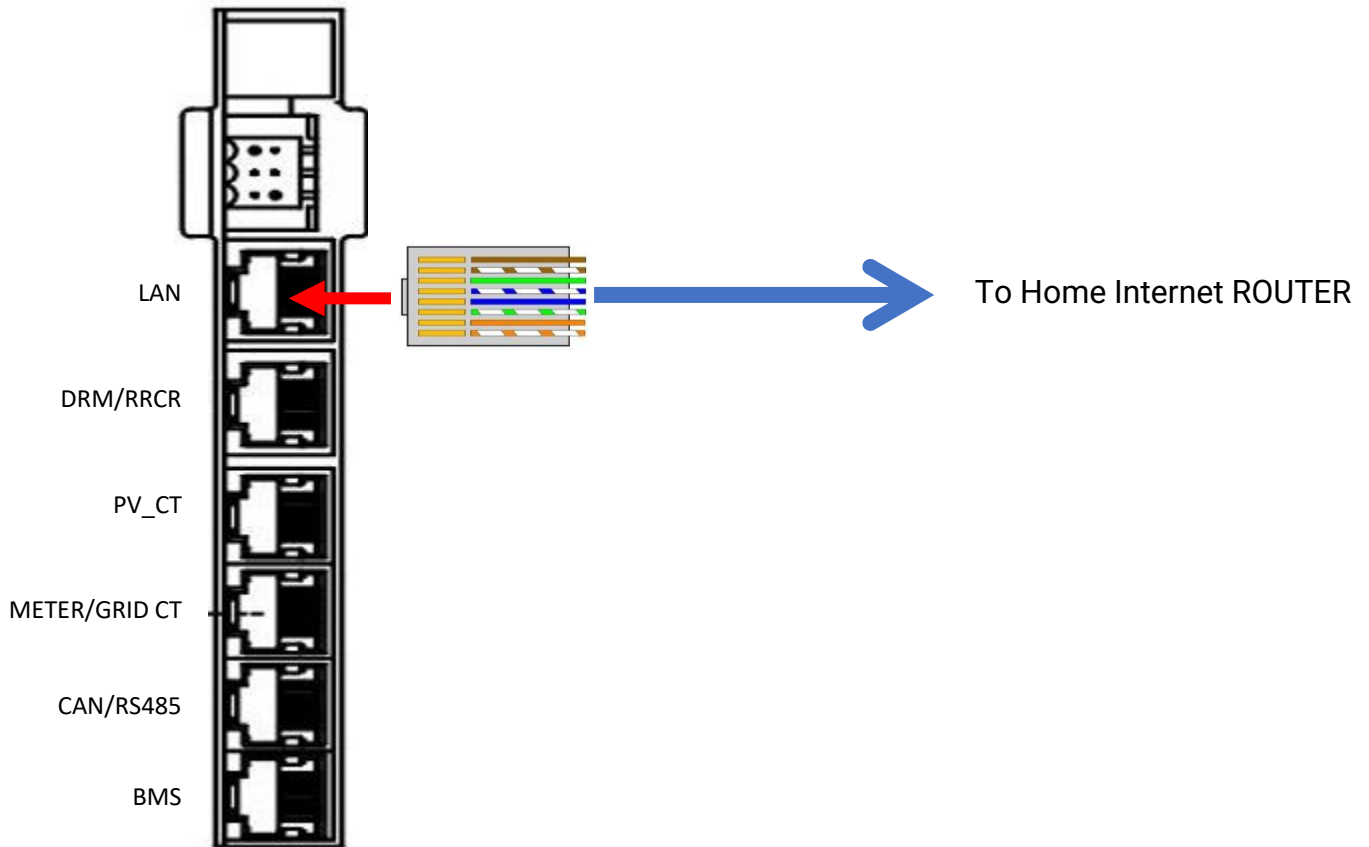

Next set a **STATIC IP** address for the ethernet connection

Inverter Setup – Ethernet network Connection

set a **STATIC IP** address for the ethernet connection

This is done via the LCD display. Follow the menu prompts.

Settings > System -> Ethernet

Default

password is

1111

Change IP Method from

DHCP to **STATIC**

Set a unique IP Address
and note it down.

The below is an EXAMPLE ONLY. DO NOT USE THIS VALUE.

The Alpha screen pads the ip address segments with zeros. Do not include the zeros when doing the sunspec manual add further down. For example, the below local IP should but put into the configurator as **192.168.0.23**

Local IP:

192.168.000.023

CATCH Commissioning Wizard

Now go back to the CATCH Configurator and restart the wizard.

1. Log into the CATCH Configurator and run the Commissioner.

2. Follow the Commissioner step by Step.

Step 6: Inverter Control

This should already be set to ALPHA ESS SMILE, when you get 3 green ticks you can continue the commissioning process

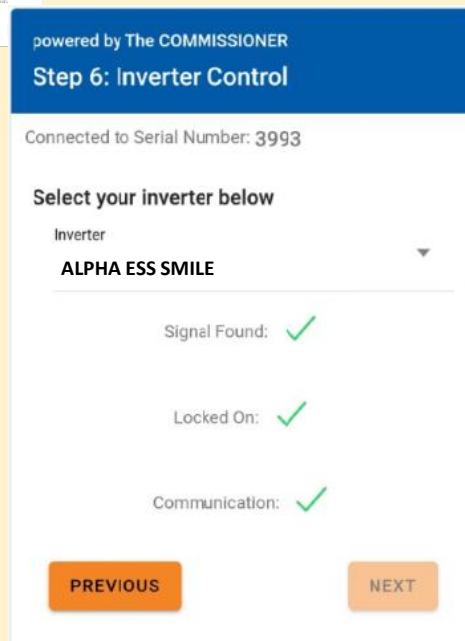
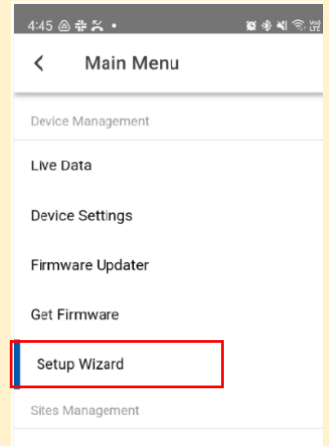

Choose: **ALPHA ESS SMILE**

You will need to get All **GREEN** ticks before you can continue.



CATCH Commissioning Wizard

Step 7: Channel Setup

In the CT configuration is setup as shown with CH1 set as MAINS and CH2 is SOLAR.

Setup Wizard

powered by The COMMISSIONER

Step 7: Channel Setup

Connected to Serial Number: 3602

INSTRUCTIONS

Channel Purpose:

We automatically set the devices channels when attaching to site. This is the default setup for a Solar Relay, however these can be changed below.

Channel Name:

Channel names are optional, by default MAINS and SOLAR channels will show on The Monocle Apps chart.

More Information:

Channel names can be changed later in The Monocle App.

Channel 1 Setup

Channel 1 Purpose
MAINS

Channel 1 Name
Enter a Channel Name (optional)

Channel 2 Setup

Channel 2 Purpose
OTHER

Channel 2 Name

Channel Readings

| Channel 1 | Channel 2 |
|--------------------|---------------------|
| MAINS | OTHER |
| Power: 750 W | Power: -20 W |
| Power Factor: 0.45 | Power Factor: -0.08 |

CT Status

✓

PREVIOUS NEXT

CATCH Commissioning Wizard

Now go back to the CATCH Configurator and restart the wizard.

Step 8: EDDE Control

choose if you want EDDE Control enabled.

You will need EDDE Control to be YES if you want any of the following features.

- Flexible Exports
- Inverter Control
- Market based pricing control such as AMBER curtailment
- EV Integration

IMPORTANT



By Enabling EDDE Control will mean the consumption data in the inverter platform is meaningless.

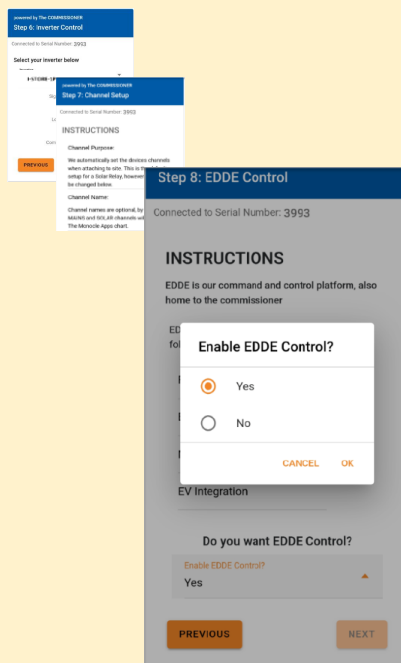

SOLAR RELAY Setup

2. Follow the Commissioner step by Step.

Step 8: EDDE Control

choose if you want EDDE Control enabled. If you choose Yes you should have set the inverter export limit to zero in the inverter configuration earlier.

NOTE:

If you choose NO to Edde Control you need to go back and set the site export in the inverter to something other than zero.

You will need EDDE Control to be YES if you want any of the following features.

- Flexible Exports
- Inverter Control
- Market based pricing control such as AMBER curtailment
- EV Integration

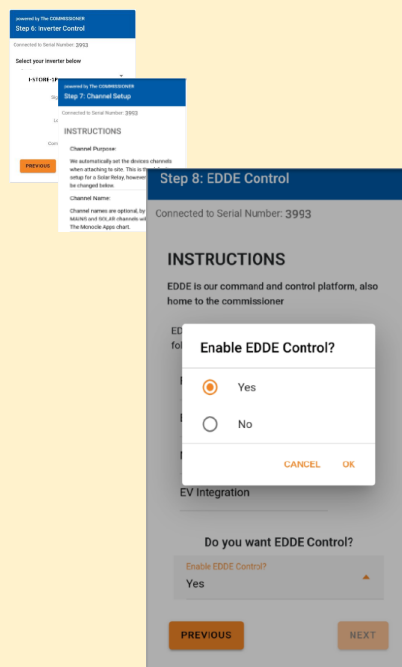

SOLAR RELAY Setup

2. Follow the Commissioner step by Step.

Step 9: EDDE Export Control

If you choose YES for EDDE Control we will take care of the site export limit, not the inverter.

There are 2 important things for you to do.

1. Make sure the solar CT is wrapped around the AC port of the inverter as shown Below.

The SOLAR CT is **W2**.

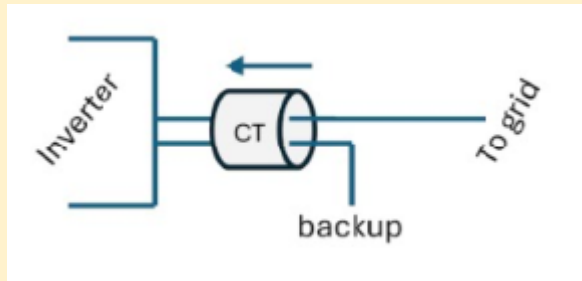

2. Make sure you configure the inverter to be ZERO exported. (You should have done that in the previous inverter configuration section)

Tell us how the export limit is to be managed.

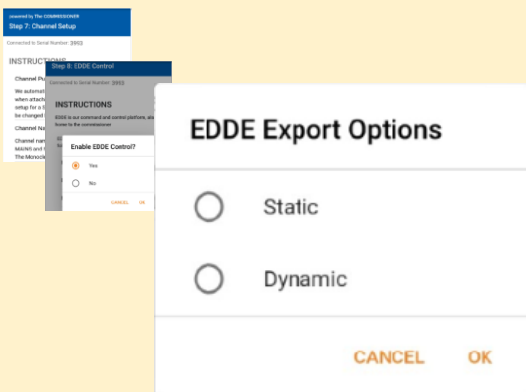

Static: Is when the DNSP tells you there is a fixed export limit. Example the connection application might say the site is limited to 5kW. This is a static export limit.

Dynamic: When you put the connection application in you would have nominated for the dynamic connection. The DNSP will adjust the export limit based on daily requirements.

You will need the NMI to complete the dynamic connection setup.

SOLAR RELAY Setup

2. Follow the Commissioner step by Step.

Step 9: EDDE Export Control..Continued

Static Export Configuration:

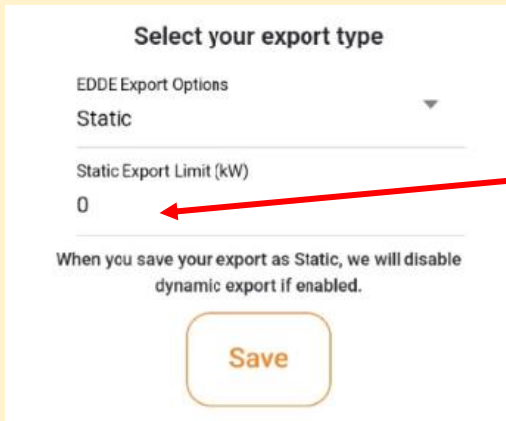

The screenshot shows a form titled "Select your export type". Under "EDDE Export Options", the "Static" option is selected. Below this, the "Static Export Limit (kW)" is set to "0". A note states: "When you save your export as Static, we will disable dynamic export if enabled." A "Save" button is at the bottom.

Fill out the export limit. For example if the site has a 5kw export limit type in 5 for the export limit and press **SAVE**

Dynamic Export Configuration:

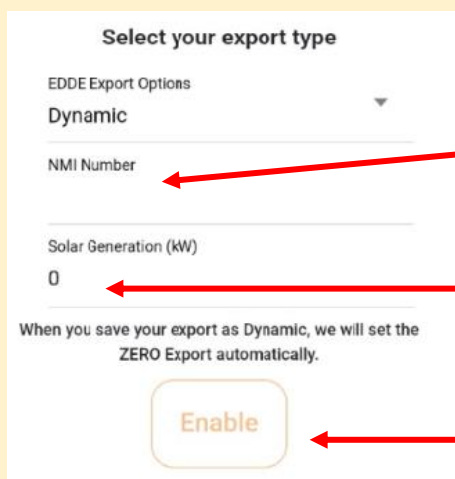

The screenshot shows a form titled "Select your export type". Under "EDDE Export Options", the "Dynamic" option is selected. Below this, the "NMI Number" field is empty. The "Solar Generation (kW)" is set to "0". A note states: "When you save your export as Dynamic, we will set the ZERO Export automatically." An "Enable" button is at the bottom.

Enter the customers NMI. This can be a 10 or 11 digit NMI.

Tells us the total amount of solar on site. Including any old systems.

Press Enable.

SOLAR RELAY Setup

2. Follow the Commissioner step by Step.

Step 9: EDDE Export Control..Continued

Dynamic Export Configuration - Continued:

Once you have filled out the required information and pressed save the follow appears and shows you how the registration for dynamic exports is progressing... You want to see all green ticks for everything to be working.

The indicators below are updated every 30sec. You need to get green ticks on all items below in order for Dynamic exporting to be operational.

Inverter Control Scheme: MIXED

✗ Registered with CATCH CSIP-AUS

This indicates all the criteria have been met for us to register this site, as a Dynamic Export site. We require Dynamic Exports to be enable and a valid NMI to be supplied.

✗ Registered with SA Power Networks

LFDI: N/A



This indicates the NMI has been accepted by the DNSP system. The LFDI is the unique identifier used by CATCH and the DNSP to identify this site. You can copy the LFDI by pressing the copy icon to the right.

✗ Measurement Data has been sent.

Last Measurement sent: 1/1/70 10:00 AM

Measurement data has been successfully sent from this site to the DNSP.

✗ Received Active Controls

Default Export(W): N/A

Active Export(W): N/A

Last Control Received: 1/1/70 10:00 AM

Indicates we have successfully received some active export controls from the DNSP.

Errors

no errors

SOLAR RELAY Setup

2. Follow the Commissioner step by Step.

Step 10: Save Configuration

The final step is to review the configuration, and Press **SAVE**.

powered by The COMMISSIONER
Step 10: Save Configuration

Connected to Serial Number: 3993

Summary

Device Information

Device Name: 3993-SRWe/CATCH
Serial Number: 3993
Firmware Version: 8305
Wifi State: Connected
Server State: Connected

Inverter Control

Inverter: Growatt MIN 2500-6000 TL-X

Signal: ✓

Locked: ✓

Communication: ✓

Export Control

Export Type: None

Live Data

Channel 1

Live Data

Channel 1
Name:
Purpose: MAINS
Power: 3.76 kW
Power Factor: -0.94
Volts: 248.9 V
Amps: 16 A
Freq: 49.94 Hz
VA: 4 kVA
VAR: 1357 var
Imported: 55.2 kWh
Exported: -114.0 kWh

Channel 2

Name: Growatt AC
Purpose: OTHER
Power: 590 W
Power Factor: 0.73
Amps: 3.2 A
VA: 0.8 kVA
VAR: 1357 var
Imported: 49.0 kWh
Exported: -0.3 kWh

PREVIOUS

SAVE

CATCH Configurator SUNSPEC SCAN

At this stage most of the CATCH Control is setup. You need to run a SUNSPEC scan in order to find the inverter on the network. We get the battery data from the inverter via the local network.

Go to device Settings

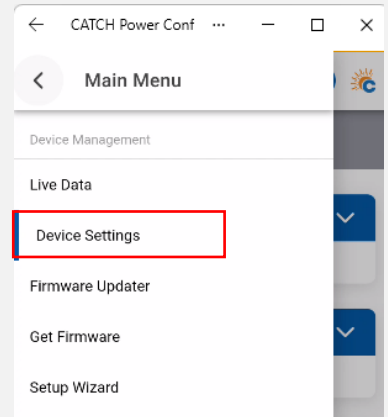

Scroll down until you get to the Sunspec Config and click on the Menu Item

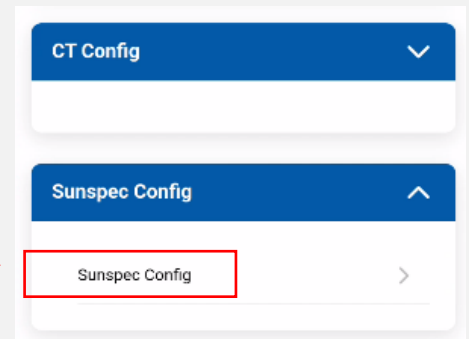

CATCH Configurator SUNSPEC SCAN

At this stage most of the CATCH Control is setup. You need to run a SUNSPEC scan in order to find the inverter on the network. We get the battery data from the inverter via the local network.

When you first come into the SUNSPEC screen all of the values are zero

and the devices screen says no devices..

The Alpha MUST be manually added

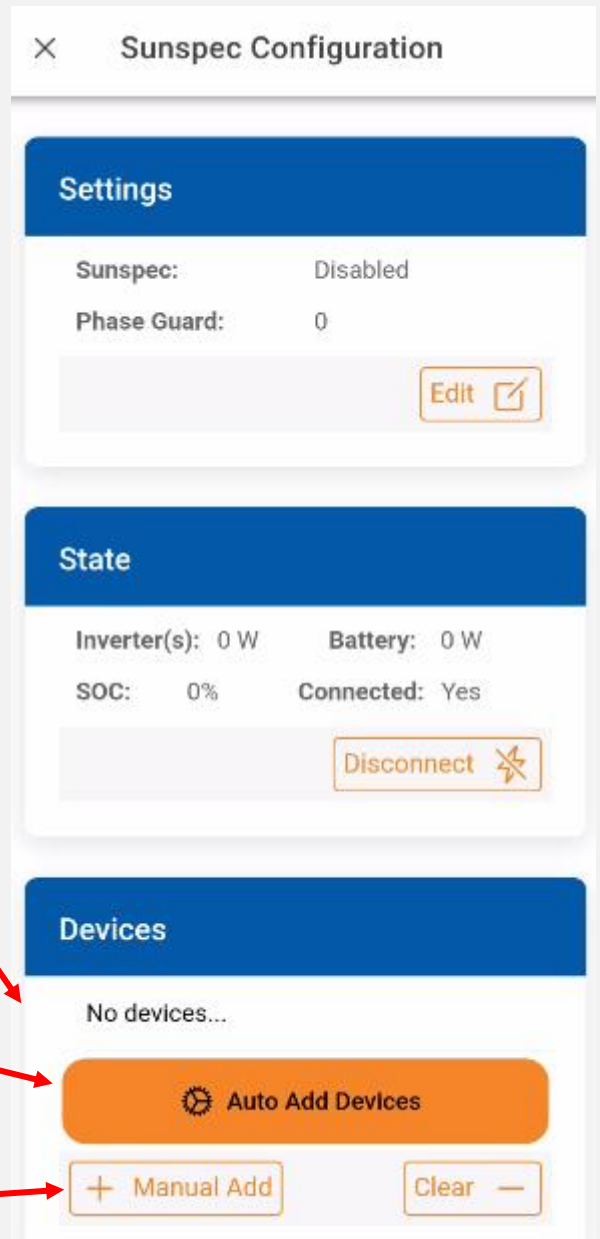

The screenshot shows the 'Sunspec Configuration' interface with three main sections: Settings, State, and Devices. Red arrows point from the text on the left to the 'Edit' button in the Settings section, the 'Disconnect' button in the State section, the 'Auto Add Devices' button in the Devices section, and the '+ Manual Add' button in the Devices section.

| Settings | |
|----------------------|----------|
| Sunspec: | Disabled |
| Phase Guard: | 0 |
| Edit | |

| State | |
|----------------------------|-----|
| Inverter(s): | 0 W |
| Battery: | 0 W |
| SOC: | 0% |
| Connected: | Yes |
| Disconnect | |

| Devices | |
|----------------------------------|-------------------------|
| No devices... | |
| Auto Add Devices | |
| + Manual Add | Clear - |

CATCH Configurator SUNSPEC SCAN

SUNSPEC – MANUAL ADD

If you setup the inverter with a static IP address this is where you put the ip address in.

Make sure to set

- Port: 502
- Slave ID: 85

The press the **ADD** button.

All going well you will get a message saying 1 device(s) added.

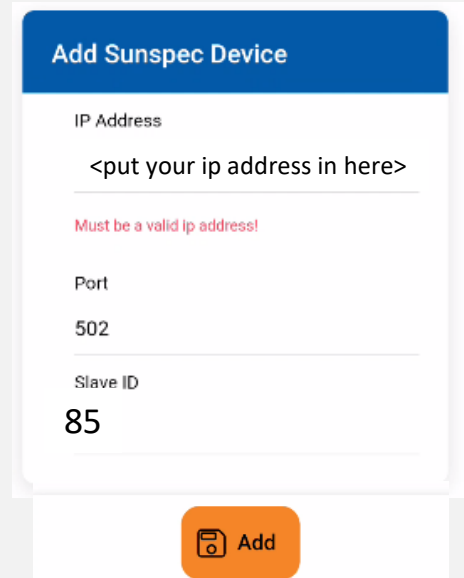

The below is an EXAMPLE ONLY. DO NOT USE THIS VALUE.

The IP Address comes from the static IP you assigned in the inverter setup. But remember to remove the zero padding. The below example should but put into the configurator as **192.168.0.23**

Local IP:

192.168.000.023

CATCH Configurator SUNSPEC SCAN

If the Sunspec device has been successfully added the Sunspec screen should look like this.

Inverter output, Battery SoC and Battery W should all have values

Click here to expand and the device should look like below

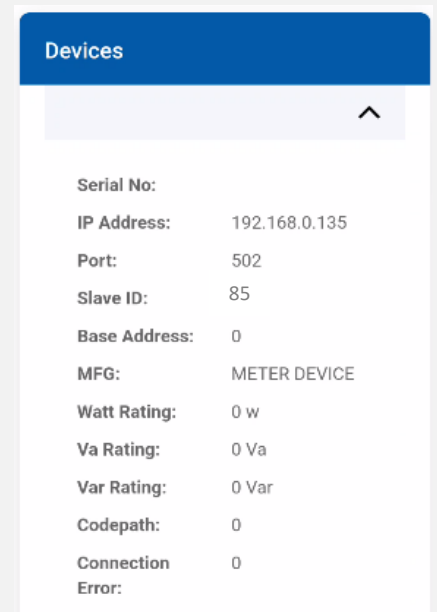
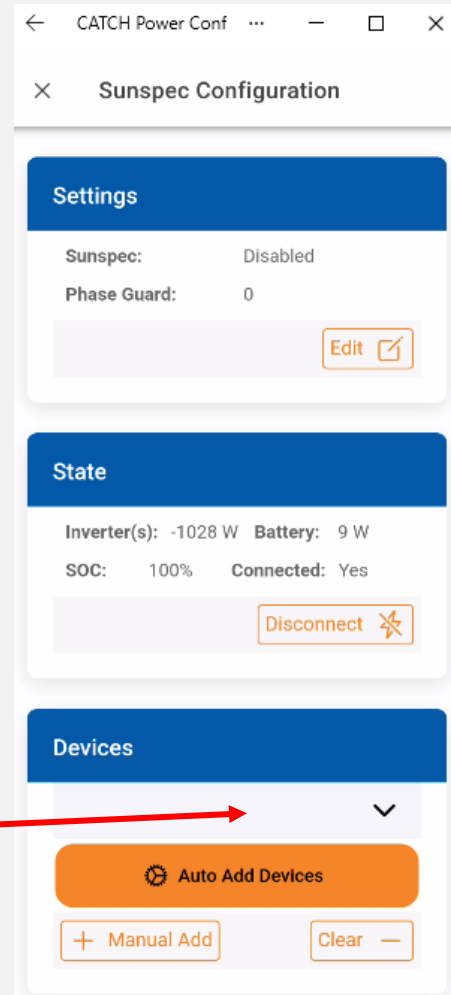

Notice the MFG says METER DEVICE. This is how it needs to be. If you see anything else or any other variation you have not connected properly to the inverter. It MUST SAY **METER DEVICE**

If you have picked up the wrong device. Press the Clear button and do it again.