



CONTROL

with iSTORE



Models:
IS-HYB-XXXX-1PH

CATCH Power
A trademark of Project H Pty Ltd
180 Dumaresq Street
Glen Innes
NSW 2370
Australia
Ph: +64 2 5700 5717
W: www.Catchpower.com.au
E: sales@catchpower.com.au

IMPORTANT



This guide discusses the specific wiring and configuration need to implement inverter control. Ensure the installation guide for both products is also followed.

Wiring Instructions

Ensure the data cable is rated for the voltages it will be in close proximity to.
A 120 Ohm terminating resistor may be required at the CATCH CONTROL terminals as shown in the diagram below if the cable run is longer than 10m.

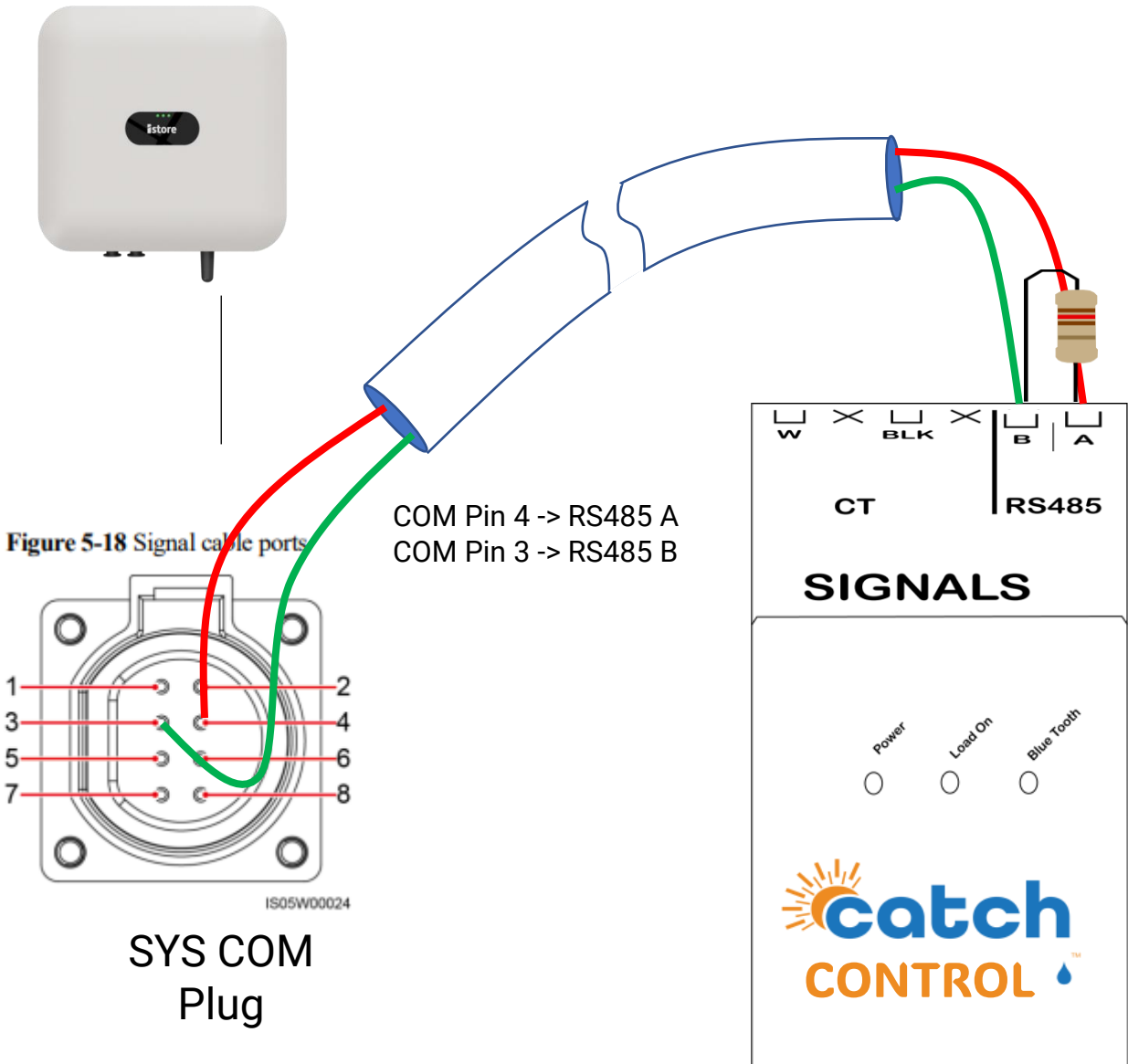

Inverter Setup

The configuration of the IStore inverter is done through the **HiSolar** App. This App is available on the Apple or Google stores.

Follow the iStore commissioning process as outline in the IS-HYB-1PH User Guide.

Once the inverter is setup as per the above guide follow these steps:

Step 1: On the home screen choose **Maintenance > Subdevice management > Power Meter**

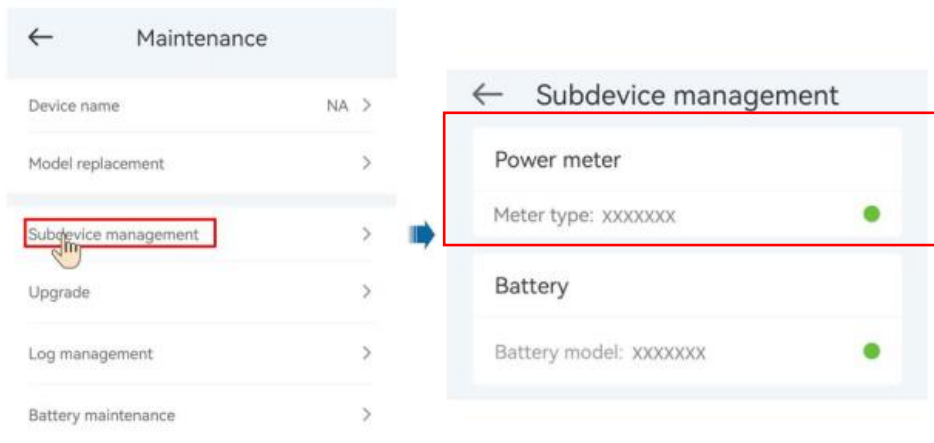

Step 2: Ensure meter **DDSU666-H** is chosen and power meter address is **11**

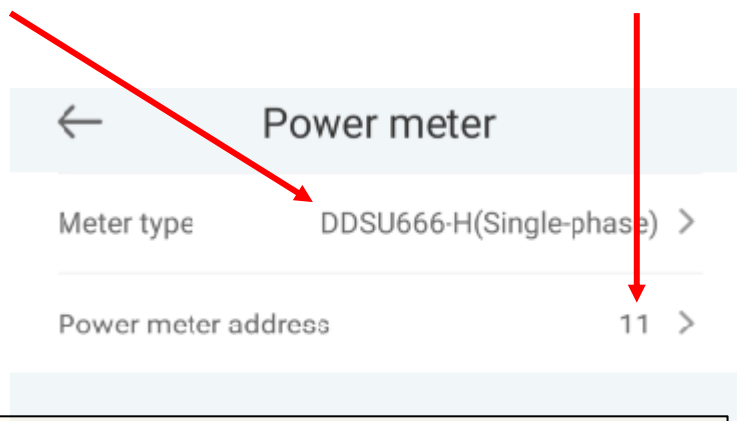

The Press **SUBMIT**

The inverter will complain and say “No Meter Found” This is ok. This error is fixed when you configure the CATCH Control in the next few steps.

Inverter Setup...Continued

Only follow the steps below if you want EDDE Control enabled.

EDDE Control needs to be enabled if you want the following features:

- Flexible Exports
- Inverter Control
- Market based pricing control such as AMBER curtailment
- EV Integration

IMPORTANT NOTES:

- By enabling EDDE Control you will loose meaningful consumption data on the inverters native platform.
- EDDE Control does not currently support battery installations for iStore.

To enable EDDE Control you need to **ZERO** export the inverter.

Following the instructions below to zero export the iStore inverter.

Step 3: On the home screen choose **Power adjustment > Grid-tied point control > Active Power**

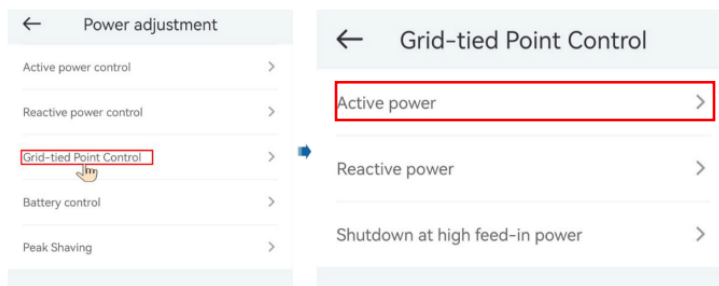

Inverter Setup

Step 4: Set the export limit to ZERO

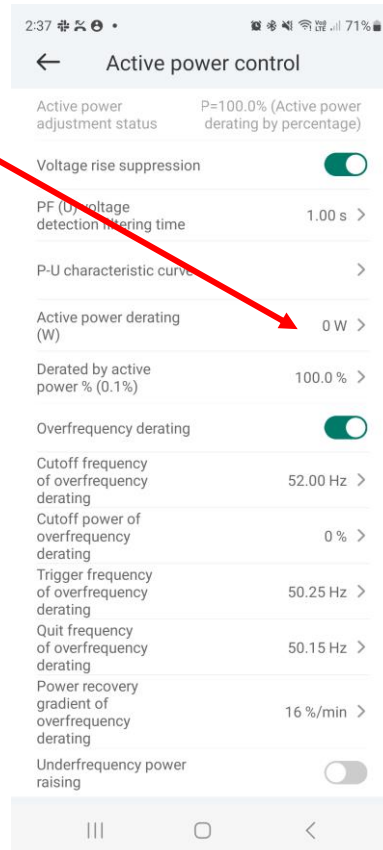

The Press **SUBMIT**

SOLAR RELAY Setup

1. Log into the CATCH Configurator and run the Commissioner.



CATCH Power Configurator

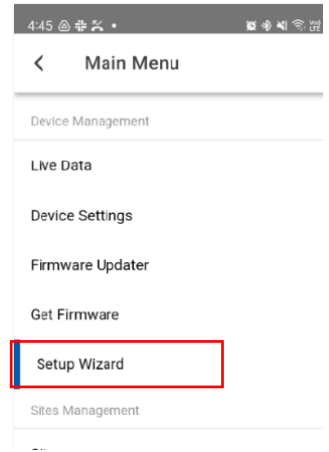

2. Follow the Commissioner step by Step.

Step 6: Inverter Control

choose **I-STORE-1P** as the meter. And make sure you get all green ticks.

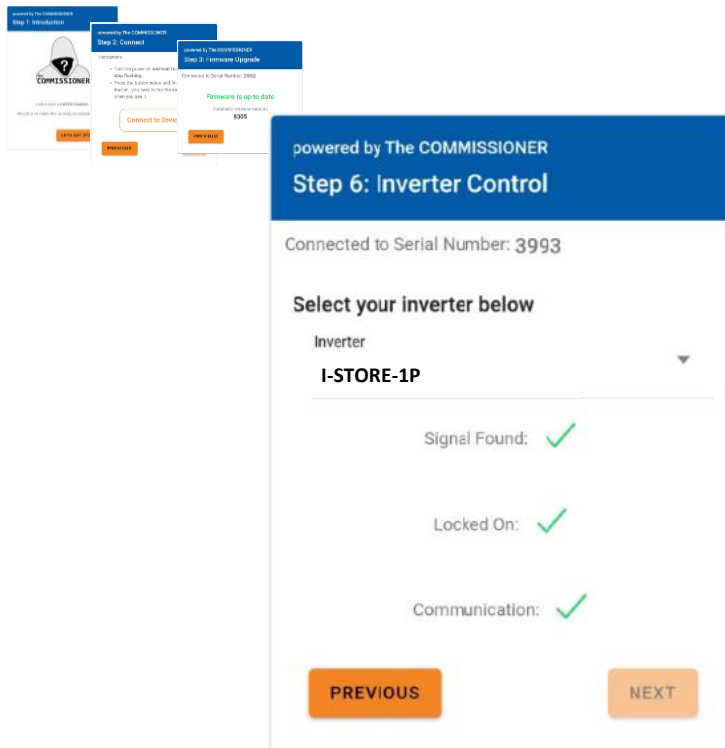

Choose: **I-STORE-1P**

You need **3** green ticks.

SOLAR RELAY Setup

2. Follow the Commissioner step by Step.

Step 8: EDDE Control

choose if you want EDDE Control enabled. If you choose Yes you should have set the inverter export limit to zero in the inverter configuration earlier.

You will need EDDE Control to be YES if you want any of the following features.

- Flexible Exports
- Inverter Control
- Market based pricing control such as AMBER curtailment
- EV Integration

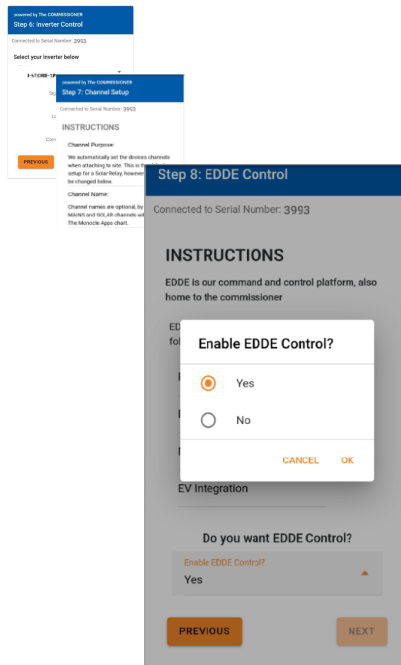

SOLAR RELAY Setup

2. Follow the Commissioner step by Step.

Step 9: EDDE Export Control

If you choose YES for EDDE Control we will take care of the site export limit, not the inverter.

There are 2 important things for you to do.

1. Make sure the solar CT is wrapped around the AC port of the inverter as shown Below.

The SOLAR CT is **W2**.

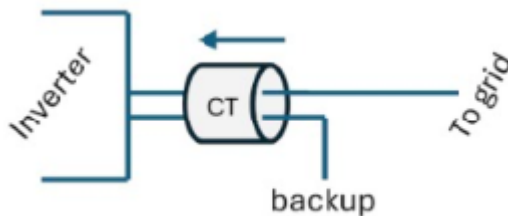

2. Make sure you configure the inverter to be ZERO exported. (You should have done that in the previous inverter configuration section)

Tell us how the export limit is to be managed.

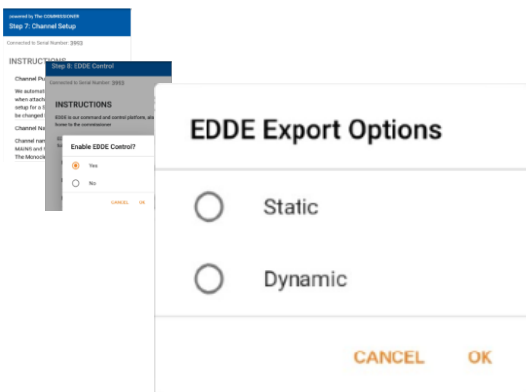

Static: Is when the DNSP tells you there is a fixed export limit. Example the connection application might say the site is limited to 5kW. This is a static export limit.

Dynamic: When you put the connection application in you would have nominated for the dynamic connection. The DNSP will adjust the export limit based on daily requirements.

You will need the NMI to complete the dynamic connection setup.

SOLAR RELAY Setup

2. Follow the Commissioner step by Step.

Step 9: EDDE Export Control..Continued

Static Export Configuration:

Select your export type

EDDE Export Options
Static

Static Export Limit (kW)
0

When you save your export as Static, we will disable dynamic export if enabled.

Save

Fill out the export limit. For example if the site has a 5kw export limit type in 5 for the export limit and press **SAVE**

Dynamic Export Configuration:

Select your export type

EDDE Export Options
Dynamic

NMI Number

Solar Generation (kW)
0

When you save your export as Dynamic, we will set the ZERO Export automatically.

Enable

Enter the customers NMI. This can be a 10 or 11 digit NMI.

Tells us the total amount of solar on site. Including any old systems.

Press Enable.

SOLAR RELAY Setup

2. Follow the Commissioner step by Step.

Step 9: EDDE Export Control..Continued

Dynamic Export Configuration - Continued:

Once you have filled out the required information and pressed save the follow appears and shows you how the registration for dynamic exports is progressing... You want to see all green ticks for everything to be working.

The indicators below are updated every 30sec. You need to get green ticks on all items below in order for Dynamic exporting to be operational.

Inverter Control Scheme: MIXED

✗ Registered with CATCH CSIP-AUS

This indicates all the criteria have been met for us to register this site, as a Dynamic Export site. We require Dynamic Exports to be enable and a valid NMI to be supplied.

✗ Registered with SA Power Networks

LFDI: N/A



This indicates the NMI has been accepted by the DNSP system. The LFDI is the unique identifier used by CATCH and the DNSP to identify this site. You can copy the LFDI by pressing the copy icon to the right.

✗ Measurement Data has been sent.

Last Measurement sent: 1/1/70 10:00 AM

Measurement data has been successfully sent from this site to the DNSP.

✗ Received Active Controls

Default Export(W): N/A

Active Export(W): N/A

Last Control Received: 1/1/70 10:00 AM

Indicates we have successfully received some active export controls from the DNSP.

Errors

no errors

SOLAR RELAY Setup

2. Follow the Commissioner step by Step.

Step 10: Save Configuration

The final step is to review the configuration, and Press **SAVE**.

CONGRATULATIONS...

INSTALLATION COMPLETE.

powered by The COMMISSIONER
Step 10: Save Configuration

Connected to Serial Number: 3993

Summary

Device Information

Device Name: 3993-SRWe/CATCH
Serial Number: 3993
Firmware Version: 8305
Wifi State: Connected
Server State: Connected

Inverter Control

Inverter: Growatt MIN 2500-6000 TL-X

Signal: ✓

Locked: ✓

Communication: ✓

Export Control

Export Type: None

Live Data

Channel 1

Live Data

Channel 1
Name:
Purpose: MAINS
Power: 3.76 kW
Power Factor: -0.94
Volts: 248.9 V
Amps: 16 A
Freq: 49.94 Hz
VA: 4 kVA
VAR: 1357 var
Imported: 55.2 kWh
Exported: -114.0 kWh

Channel 2
Name: Growatt AC
Purpose: OTHER
Power: 590 W
Power Factor: 0.73
Amps: 3.2 A
VA: 0.8 kVA
VAR: 1357 var
Imported: 49.0 kWh
Exported: -0.3 kWh

PREVIOUS

SAVE